

Parts List

The following parts are included in the carton. Separate and check to see that all parts are accounted for before starting to assemble. If you are missing any parts, call the customer service number listed below and request that the missing parts be sent to you.

- A. Door Face Frame (1)
- B. Side Panels (2)
- C. Shelf (1)
- D. Bottom (1)
- E. Back Panel (1)
- F. Hardware Bag (1), Corner Braces (4), Drawer Slide Holders (4), Shelf Holders (4), Small Screws (20), Medium Screws (16), Largest Screws (4)
- G. Drawer Slide (4)
- H. Drawer Parts: a. Front (1), b. Sides with Slides (2), c. Back (1), d. Bottom (1), Dowels (8), Drawer Screws (4), Drawer Nuts (4)
- J. Toe Kick Plate (1)

Assembly Steps

- Step 1. Remove the base unit parts and make sure all are accounted for. Place the door face frame (A) with the door facing down on a flat, soft working surface.
- Step 2. Insert the two side panels (B) into the grooves on each side of the face frame (A). Align the plastic half sections of the cam lock connectors. The half connector on the side panels should cover the plastic connector on the face frame and be flush. Using a screwdriver, turn the cam lock to the right 180 degrees (ref. Figure 1).
- Step 3. Insert bottom (D) into the grooves in the side panels (B) and into the grooves in the face frame (A).

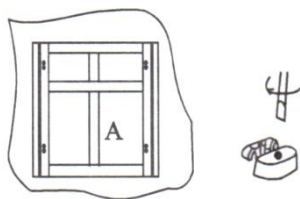

Figure 1(Soft Surface, Cam Lock Connector)

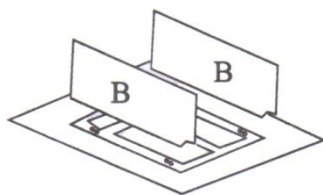

Figure 2

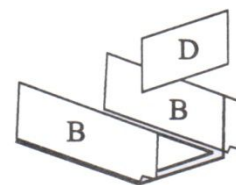

Figure 3



Step 4. Place the back panel (E) onto the side panels (B) so that the groove fits over the bottom (D) and the plastic connector halves align and fit together flush, then turn the cam lock 180 degrees to tighten. Place the toe kick plate (J) onto the side panels (B) at the front side of the cabinet. Confirm that the plastic connector halves are aligned and flush then tighten.

Step 5. Stand the cabinet upright and attach the 4 plastic corner braces in each corner of the cabinet using the small screws. (Note: The largest screws are used later to attach the counter top to the base cabinet through the corner braces.)

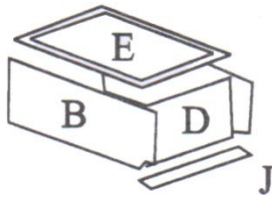

Figure 4

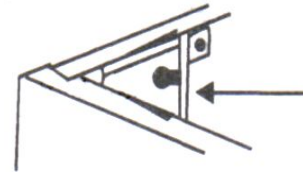
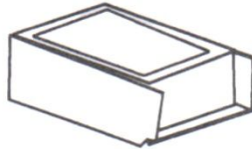

Figure 5 (Corner Brace)

Step 6. Drawer Assembly: Place the dowels and drawer nuts into the drawer front (a) and drawer back (c). Align the dowels with the holes on one of the side panels (b) and press together. Insert the drawer screws and tighten the side to the front and back panels. (Note: Make sure that the slots for the bottom panel are aligned. Insert the bottom panel (d). Position the other side panel and assemble with the screws.)

Step 7. Slide the right and left drawer slide (G) into the drawer slide holders. Position left drawer slide with the holder into the drawer pocket in the cabinet with the plastic holder to the back of the cabinet (as shown below). Use a small screw to fasten the front of the drawer slide to the face frame (A) using the predrilled hole. Then fasten the plastic holder to the back of the cabinet aligning to the spotted hole (3). Repeat these steps to mount the other drawer slides. Insert the drawers.

Step 8. Your base cabinet is now complete. Follow the installation tips or consult a contractor for proper installation. After mounting the cabinet to the wall, insert the shelf clips into the holes in the cabinet side panels at the desired height and slide in the shelves (C).

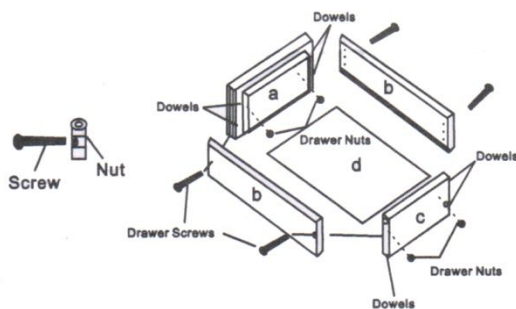

Figure 6

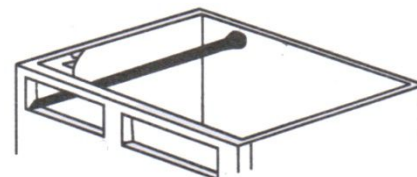

Figure 7

CAUTION: THESE CABINETS ARE NOT DRILLED FOR HARDWARE, SO THAT YOU MAY SELECT THE STYLE AND FINISH FOR YOUR PERSONAL DÉCOR. PLEASE BE CAREFUL AND CHECK YOUR MEASUREMENTS SEVERAL TIMES PRIOR TO DRILLING HOLES AS THE PROODUCT WARRANTY DOES NOT COVER DAMAGE OR PROBLEMS CAUSED BY MISS-DRILLING.

